

DISTRIBUTORS

2024

CATÁLOGO
DE
REFERENCIAS



OUR PRODUCTS



SOLUTIONS FOR TV

- Lifts
- Rotating
- In-Ceiling
- In-Wall
- Panels
- Under-Bed



KITCHEN SOLUTIONS

- Lifts
- Tops
- Tables
- Others



SPECIAL

- C-bed
- Hidden doors
- Video Projectors



TELEVISION

TV SOLUTIONS



UP/DOWN SYSTEMS

TV LIFT

Motorized Tv lifts for concealed installation



ROTATING SYSTEMS

ROTATING

Motion Tv systems with rotation



CEILING SYSTEMS

IN-CEILING

Tv mechanisms for in-ceiling installation



WALL SYSTEMS

IN-WALL

Tv mechanisms for in-wall installation

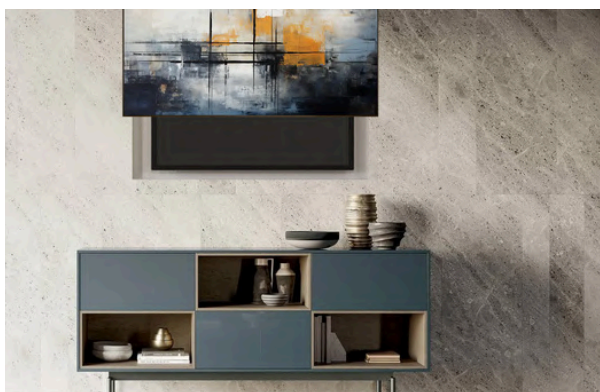

PANEL SYSTEMS

PANELS

Panel motorized motion systems



UNDER BED SYSTEMS

UNDER BED

Tv mechanisms for underbed installation



LIFTS

UP/DOWN SYSTEMS

Index

Tv Lifts

- Up-Down.....7
- Up-Down AL.....8
- Alzo Zero.....9
- Column lift.....10

UP-DOWN TV LIFTS

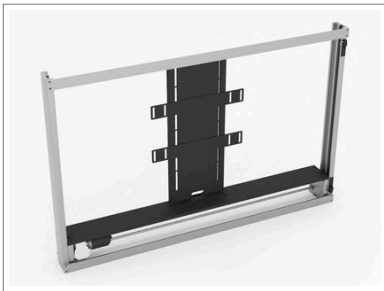

STANDARD VERSION - 4G

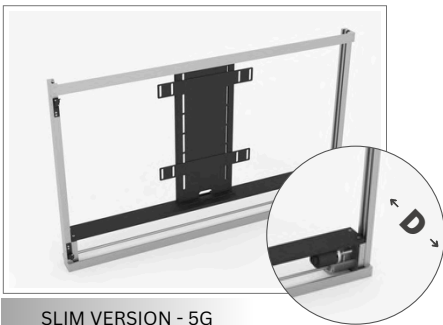

SLIM VERSION - 5G

CHARACTERISTICS



ULTRA SLIM







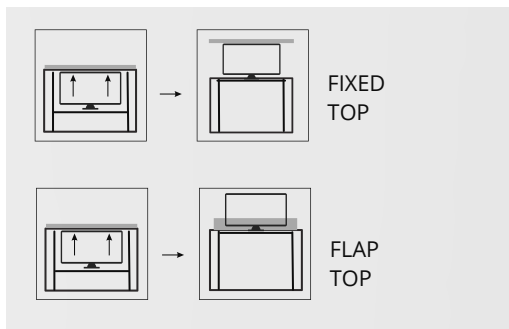



TV USEFUL SPACE < 4G xxMM

OPENING OPTIONS FOR TOP





SUPPLIED



MODEL	DESCRIPTION	USEFUL TV	HEIGHT	PRICE	
				4G	5G
 7031	Automated tv lift up/down	Max 32"	660/700/730	CONSULTAR	CONSULTAR
 7040	Automated tv lift up/down	Max 40"	700/730/780	CONSULTAR	CONSULTAR
 7042	Automated tv lift up/down	Max 42"	730/780/820/850	CONSULTAR	CONSULTAR
 7043	Automated tv lift up/down	Max 43"	820/850	CONSULTAR	CONSULTAR
 7050	Automated tv lift up/down	Max 50"	850/890/920	CONSULTAR	CONSULTAR
 7065 	Automated tv lift up/down	Max 65"	1020	CONSULTAR	NA
 7080 	Automated tv lift up/down	over 65"	custom	CONSULTAR	

 OUTDOOR VERSION
(EXTRA PRICE UP TO 7050 | FROM 7065)

 COVERING BOX EXTRA PRICE

 DEDICATED WOODEN BOX (EXTRA)

UP-DOWN + MOTORIZED CONCEALING TOP

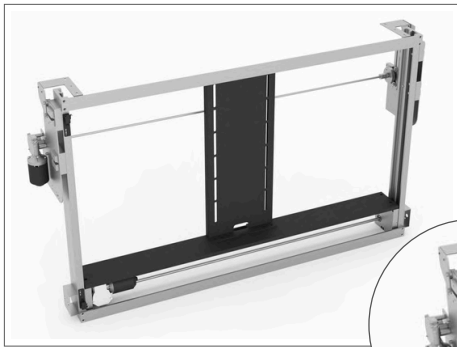

UP-DOWN AL SERIES

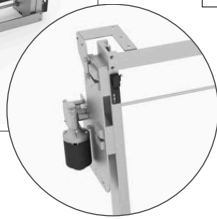

CHARACTERISTICS



AUTOMATED TOP OPENING



USEFUL TV HEIGHT < 30MM
W.R.T. UP-DOWN SERIES

AUTOMATED TOP OPENING

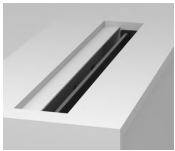
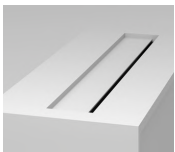

AUTOMATED TOP OPENING



MOTORIZED



REMOTE CONTROL



CONCEALED

MODEL	DESCRIPTION	USEFUL TV	HEIGHT	PRICE
7031 AL	Up/Down with automated top	Max 32"	660/700/730	CONSULTAR
7040 AL	Up/Down with automated top	Max 40"	700/730/780	CONSULTAR
7042 AL	Up/Down with automated top	Max 42"	730/780/820/850	CONSULTAR
7043 AL	Up/Down with automated top	Max 43"	820/850	CONSULTAR
7050 AL	Up/Down with automated top	Max 50"	850/890/920	CONSULTAR
7065 AL	Up/Down with automated top	Max 65"	1020	CONSULTAR
7080 AL	Up/Down with automated top	oltre/over 65"	custom	CONSULTAR



DEDICATED WOODEN BOX FOR ALL THE MODELS OF THIS SERIES
(EXTRA)

ALZO ZERO TV LIFTS

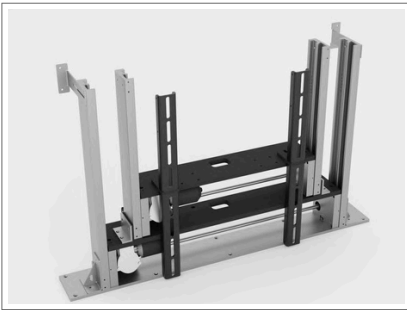

LIFTING 4G > 5G



OVER 55"



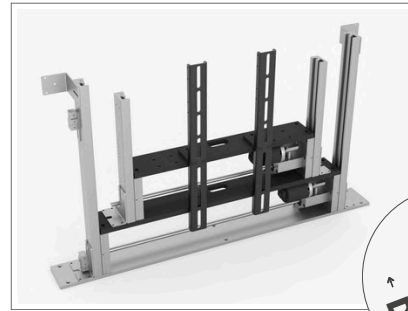

ALZO ZERO SERIES - STANDARD VERSION 4G

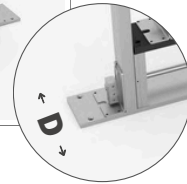

ULTRA SLIM



SLIM VERSION 5G

MODEL	DESCRIPTION	USEFUL TV	INSTALLATION	PRICE	
				4G	5G
 7004 AZ 660	Double stroke Tv lift	32" - 43"	FIXED TOP / FLAP TOP	CONSULTAR	CONSULTAR
 7004 AZ 680	Double stroke Tv lift	48"	FIXED TOP / FLAP TOP	CONSULTAR	CONSULTAR
 7004 AZ 740	Double stroke Tv lift	50" - 55"	FIXED TOP / FLAP TOP	CONSULTAR	CONSULTAR
 7004 AZ 1020	Double stroke Tv lift	MAX 75"	FIXED TOP ONLY	CONSULTAR	NA

 OUTDOOR VERSION (EXTRA)

OPTIONAL



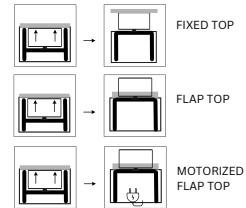

OPTIONAL ALZO ZERO

TOP OPENING OPTIONS

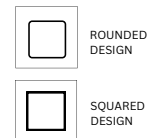
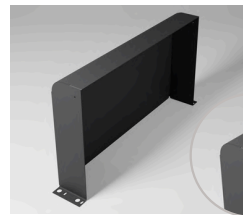

BACK TV CASE OPTIONS



MODEL	DESCRIPTION	PRICE
AZ CARTER	Back Tv covering case	CONSULTAR
AZ SP 7004	Motorized flap top	CONSULTAR
AZ BOX 7004	Outdoor Box 	CONSULTAR

COLUMN TV LIFTS



YO-YO SERIES

CHARACTERISTICS

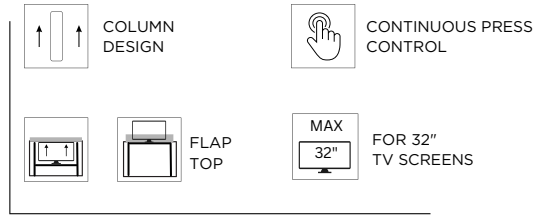



MODEL	DESCRIPTION	USEFUL TV	PRICE
7900 H600 YO-YO	Column Tv Lift	max 32"	CONSULTAR
7900 H600 YO-YO TM	Column Tv Lift with manual swivel	max 32"	CONSULTAR

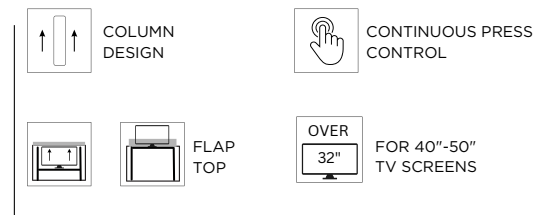

BIG YO-YO SERIES

CHARACTERISTICS



MODEL	DESCRIPTION	USEFUL TV	PRICE
7901 L BIG YO-YO	Column Tv Lift	max 40"	CONSULTAR
7902 XL BIG YO-YO	Column Tv Lift	max 43"	CONSULTAR
7903 XXL BIG YO-YO 	Column Tv Lift	da/from 43"	CONSULTAR



DEDICATED WOODEN BOX (EXTRA)



ROTATING

ROTATING SYSTEMS

Index

ROTATING

- TM/TS.....12
- TM/TS AL.....13
- Alzo Zero TM.....14
- TSL.....15
- Swivel Base15

TM/TS SERIES

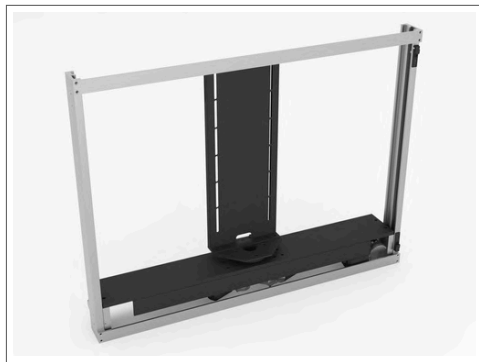





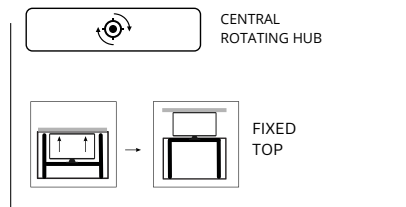

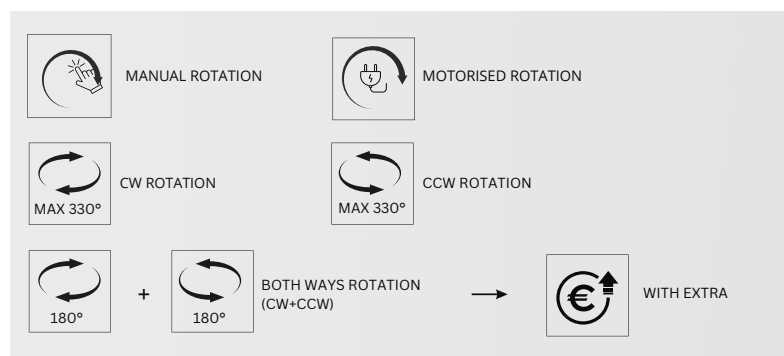

TV LIFT WITH SWIVEL

CHARACTERISTICS



SWIVELLING OPTIONS



MODEL	DESCRIPTION	USEFUL TV	HEIGHT	PRICE	
				TM	TS
 7031 TM/TS	Swivelling TV Lift	Max 32"	700/730	CONSULTAR	CONSULTAR
 7040 TM/TS	Swivelling TV Lift	Max 40"	730/780	CONSULTAR	CONSULTAR
 7042 TM/TS	Swivelling TV Lift	Max 42"	780/820/850	CONSULTAR	CONSULTAR
 7043 TM/TS	Swivelling TV Lift	Max 43"	850/890	CONSULTAR	CONSULTAR
 7050 TM/TS	Swivelling TV Lift	Max 50"	890/920	CONSULTAR	CONSULTAR
 7065 TM/TS	Swivelling TV Lift	Max 65"	1040	CONSULTAR	CONSULTAR
 7080 TM/TS	Swivelling TV Lift	oltre/over 65"	custom	CONSULTAR	

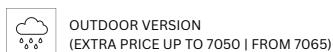

TS/TM SERIES AL



TV LIFT WITH SWIVEL AL

CHARACTERISTICS



AUTOMATED TOP OPENING



USEFUL TV HEIGHT < 30MM
W.R.T. UP-DOWN TS SERIES

AUTOMATED TOP OPENING

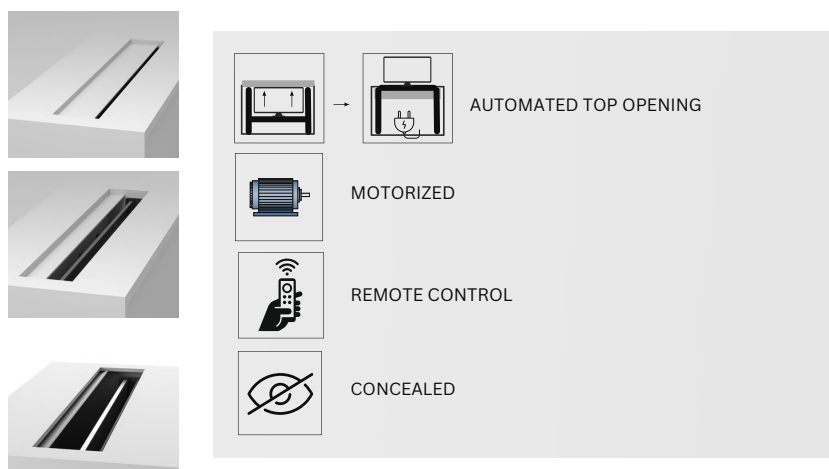

TM - TS AL SERIES

MODEL	DESCRIPTION	USEFUL TV	HEIGHT	PRICE	
				TM	TS
7031 TM/TS AL	Swivelling TV Lift with automated top	Max 32"	700/730	CONSULTAR	CONSULTAR
7040 TM/TS AL	Swivelling TV Lift with automated top	Max 40"	730/780	CONSULTAR	CONSULTAR
7042 TM/TS AL	Swivelling TV Lift with automated top	Max 42"	780/820/850	CONSULTAR	CONSULTAR
7043 TM/TS AL	Swivelling TV Lift with automated top	Max 43"	850/890	CONSULTAR	CONSULTAR
7050 TM/TS AL	Swivelling TV Lift with automated top	Max 50"	890/920	CONSULTAR	CONSULTAR
7065 TM/TS AL	Swivelling TV Lift with automated top	Max 65"	1040	CONSULTAR	CONSULTAR
7080 TM/TS AL	Swivelling TV Lift with automated top	oltre/over 65"	su misura/custom	CONSULTAR	



MANUAL SWIVEL



MOTORIZED SWIVEL



DEDICATED WOODEN BOX FOR ALL THE MODELS OF THIS SERIES (EXTRA)

ALZO-ZERO TM

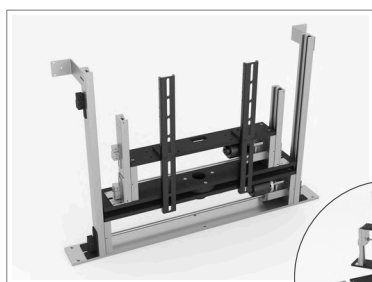

AZ TM SERIES

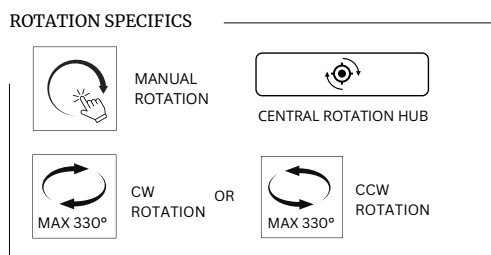

MODEL	DESCRIPTION	USEFUL TV	INSTALLATION	PRICE	
				4G	5G
7004 AZ TM 660	Double stroke Tv lift with manual swivel	32" - 40"	FIXED TOP ONLY	ND	CONSULTAR
7004 AZ TM 680	Double stroke Tv lift with manual swivel	43"	FIXED TOP ONLY	ND	CONSULTAR
7004 AZ TM 740	Double stroke Tv lift with manual swivel	50"	FIXED TOP ONLY	ND	CONSULTAR
7004 AZ TM 1020	Double stroke Tv lift with manual swivel	MAX 65"	FIXED TOP ONLY	CONSULTAR	ND



OPTIONAL



ALZO ZERO OPTIONAL

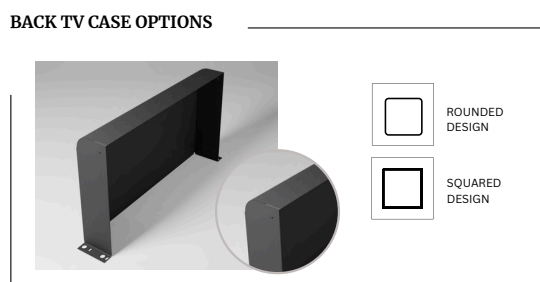
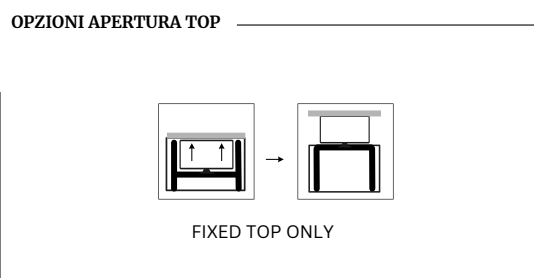

MODEL	DESCRIPTION	PRICE
AZ CARTER	Back Tv covering case	CONSULTAR
AZ BOX 7004	Outdoor Box	CONSULTAR

TV LIFT WITH LATERAL ROTATION



TECH SPECS

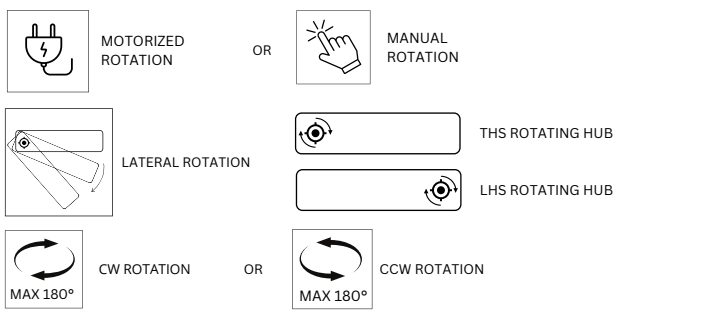

TSL SERIES

TSL - TML SERIES

MODEL	DESCRIPTION	USEFUL TV	PRICE	
			TML	TSL
7031 TML/TSL	Tv Lift with lateral rotation	Max 32"	CONSULTAR	CONSULTAR
7042 TML/TSL	Tv Lift with lateral rotation	Max 42"	CONSULTAR	CONSULTAR
7050 TML/TSL	Tv Lift with lateral rotation	Max 50"	CONSULTAR	CONSULTAR

OUTDOOR VERSION (EXTRA)

DEDICATED WOODEN BOX (EXTRA)

SWIVEL BASE



SWIVELLING OPTIONS

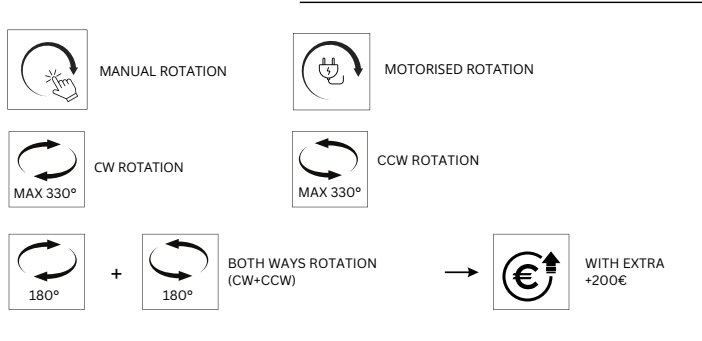

TS BASE SERIES



FINISH PANEL ON BACK OF TV NOT INCLUDED (MADE BY OTHERS)

BASE ROTANTE

MODEL	DESCRIPTION	USEFUL TV	PRICE
7274 TS	Swivelling base system	MAX 55"	CONSULTAR
7274 TS C	Swivelling base system	OVER 55"	CONSULTAR



PANELS

PANEL SYSTEMS

Index

PANEL

- Panel Systems.....17
- Twin Panel Systems.....17
- Coplanar Systems.....18
- Twin Coplanar Systems.....18
- PS - Advancing Tv.....18

SLIDING PANELS



SINGLE PANEL SYSTEM

CHARACTERISTICS

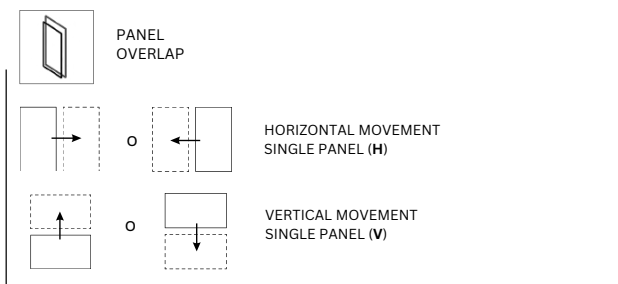

SLIDING SYSTEM FOR SINGLE PANEL

MODEL	DESCRIPTION	USEFUL TV	MECHANISM DIMENSIONS*	STROKE	PRICE
7004 P V	Single panel system	MAX 43"	W=1000mm H780mm	600mm	CONSULTAR
7004 P H	Single panel system	MAX 43"	W=1200mm H480mm	1020mm	CONSULTAR
7004 P V	Single panel system	MAX 55"	W=1200mm H890mm	760mm	CONSULTAR
7004 P V	Single panel system	MAX 65"	W=1500mm H1050mm	870mm	CONSULTAR
7004 P V	Single panel system	MAX 75"	W=1600mm H1250mm	1020mm	CONSULTAR

* THE DIMENSIONS OF THIS LINE ARE UNDER REVISION AND MAY BE SUBJECT TO CHANGE.



TWIN PANEL SYSTEM

CHARACTERISTICS

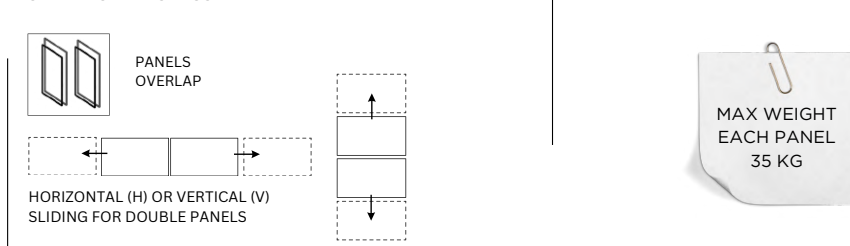

SLIDING SYSTEM FOR MULTIPLE PANEL

MODEL	DESCRIPTION	USEFUL TV	MECHANISM DIMENSIONS*	STROKE	PRICE
7004 P TWIN V	Double panel system	MAX 55"	W=1200mm H500mm x2	370mm x2	CONSULTAR
7004 P TWIN H	Double panel system	MAX 55"	W=820mm H480mm x2	640mm x2	CONSULTAR
7004 P TWIN V	Double panel system	MAX 55"	W=1500mm H550mm x2	420mm x2	CONSULTAR
7004 P TWIN H	Double panel system	MAX 55"	W=1020mm H480mm x2	790mm x2	CONSULTAR
7004 P TWIN V	Double panel system	MAX 55"	W=1600mm H650mm x2	520mm x2	CONSULTAR
7004 P TWIN H	Double panel system	MAX 55"	W=1150mm H480mm x2	920mm x2	CONSULTAR

* THE DIMENSIONS OF THIS LINE ARE UNDER REVISION AND MAY BE SUBJECT TO CHANGE.

DEDICATED WOODEN BOX (EXTRA)

COPLANAR PANEL SERIES



SINGLE APT SYSTEM



TWIN APT SYSTEM

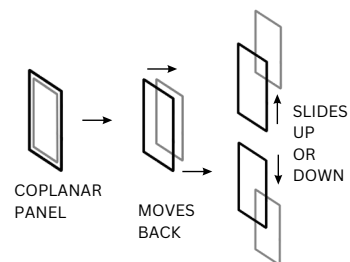

SLIDING SYSTEM FOR COPLANAR PANELS

MODEL	DESCRIPTION	USEFUL TV	COMPARTMENT DIM.	PRICE	
				PANEL 20 KG	PANEL 45 KG
7801 APT	Coplanar panel system - Single	MAX 43"	W 1200 H850	CONSULTAR	CONSULTAR
7801 APT	Coplanar panel system - Single	MAX 55"	W 1400 H950	CONSULTAR	CONSULTAR
7801 APT	Coplanar panel system - Single	MAX 65"	W 1600 H1040	ND	CONSULTAR
7801 APT	Coplanar panel system - Single	75"+	W 1900 H1100 BESPOKE	ND	CONSULTAR
7801 APT TWIN	Coplanar panel system - Double	MAX 65"	W 1600 H560 x2	ND	CONSULTAR
7801 APT TWIN	Coplanar panel system - Double	75"+	W 1700 H600 x2	ND	CONSULTAR



DEDICATED WOODEN BOX (EXTRA)

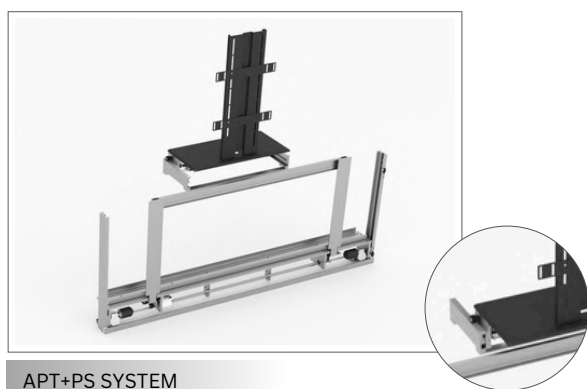

APT+PS SYSTEM

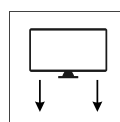

ADVANCING TV SCREEN

ADVANCING TV AFTER PANEL MOVEMENT

MODEL	DESCRIPTION	USEFUL TV	INSTALLATION	PRICE
7800 PS	Advancing Tv movement	40-55"	TOP FISSO FIXED TOP	CONSULTAR
7800 PS TS	Advancing Tv movement with rotation	40-55"	TOP RIBALTA FLAP TOP	CONSULTAR



WALL

WALL TV MOUNT

Index

- Wall.....20
- Wall TS.....20
- Wall TSL.....20

WALL SERIES

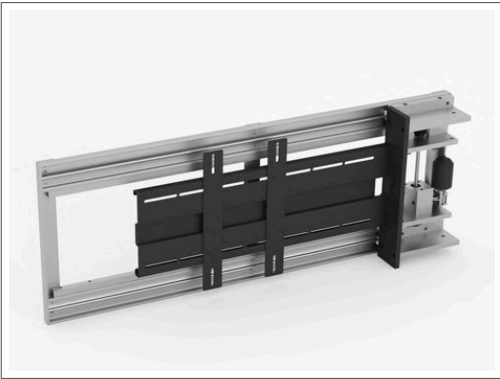

WALL SYSTEM

CHARACTERISTICS

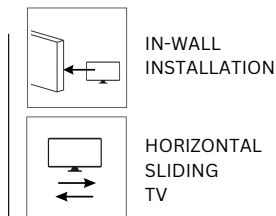

IN-WALL TV SLIDING SYSTEMS

MODEL	DESCRIPTION	USEFUL TV	PRICE
7032 W	Wall bracket	Max 32"	CONSULTAR
7042 W	Wall bracket	Max 42"	CONSULTAR
7050 W 	Wall bracket	Max 55"	CONSULTAR



DEDICATED WOODEN BOX (EXTRA)

WALL + SWIVEL



WALL CENTRAL ROTATION

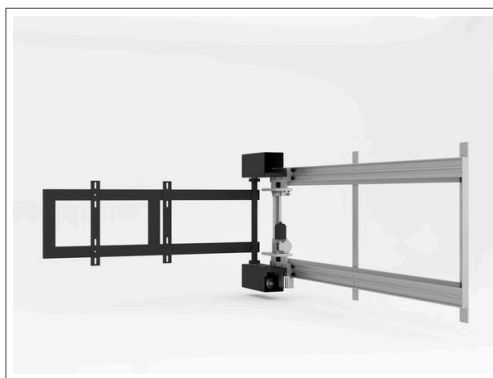

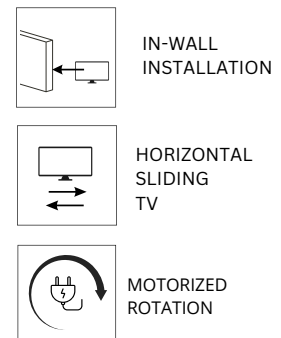

WALL LATERAL ROTATION

CHARACTERISTICS



IN-WALL TV SLIDING SYSTEMS WITH ROTATION

MODEL	DESCRIPTION	USEFUL TV	PRICE	
			TS 	TSL 
7042 W TS/TSL	Wall bracket with rotation	Max 43"	CONSULTAR	CONSULTAR
7050 W TS/TSL	Wall bracket with rotation	Max 55"	CONSULTAR	CONSULTAR



DEDICATED WOODEN BOX (EXTRA)



CEILING

TV FLIP SYSTEMS

Index

Flip down

- Covered.....22
- Naked.....24

With swivel

- Covered TS.....23
- Naked TS.....25

With telescopic lift

- Naked BS Yo.....26
- Naked BS TS Yo..27

COVERED CEILING SYSTEMS

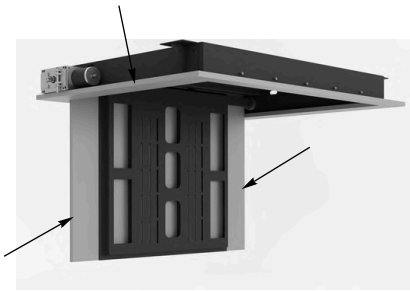

FINISH CEILING
PANEL MADE
BY OTHERS

BS ID SERIES



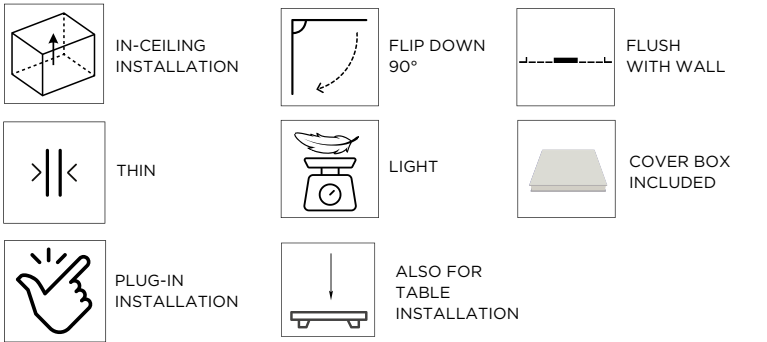

CHARACTERISTICS

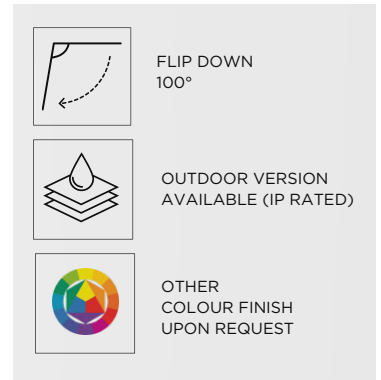

OPTIONAL



BS ID SERIES

MODEL	DESCRIPTION	USEFUL TV	PRICE
 7032 BS ID	Flip Down Ceiling Mount	Max 32"	CONSULTAR
 7042 BS ID	Flip Down Ceiling Mount	Max 43"	CONSULTAR
 7055 BS ID*	Flip Down Ceiling Mount	Max 55"	CONSULTAR
 7065 BS ID*	Flip Down Ceiling Mount	Max 65"	CONSULTAR
 7075 BS ID	Flip Down Ceiling Mount	Max 75"	CONSULTAR

*Also available
120 mm
in depth



ROTATING COVERED CEILING SYSTEMS



BS TS SERIES

ROTATION

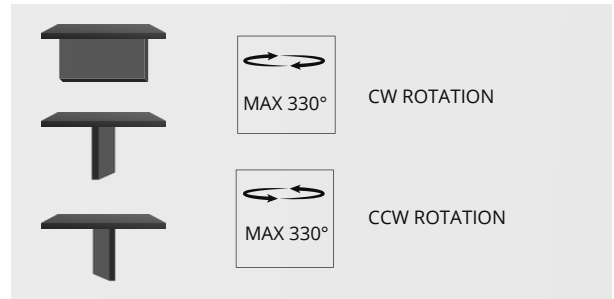

CHARACTERISTICS

	IN-CEILING INSTALLATION		FLIP DOWN 90°		FLUSH WITH WALL
	THIN		LIGHT		COVER BOX INCLUDED
	PLUG-IN INSTALLATION		MOTORISED ROTATION		ALSO FOR TABLE INSTALLATION

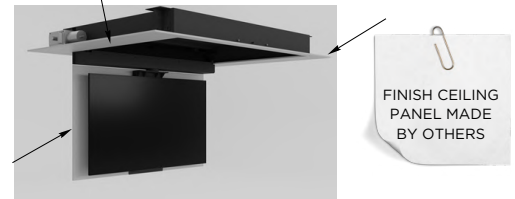

BS ID SERIES

MODEL	DESCRIPTION	USEFUL TV	PRICE
7042 BS TS ID	Flip Down Ceiling Mount with swivel	Max 43"	CONSULTAR
7055 BS TS ID <input type="checkbox"/>	Flip Down Ceiling Mount with swivel	Max 55"	CONSULTAR
7065 BS TS ID <input type="checkbox"/>	Flip Down Ceiling Mount with swivel	Max 65"	CONSULTAR
7075 BS TS ID <input type="checkbox"/>	Flip Down Ceiling Mount with swivel	Max 75"	CONSULTAR

OUTDOOR VERSION AVAILABLE (EXTRA)

OTHER COLOUR FINISH ON REQUEST (EXTRA)

DEDICATED WOODEN BOX (EXTRA)

FRAME SUPPORTING FINISH PANEL (EXTRA)
(HIGHLY SUGGESTED FROM MODEL 7055)

NAKED CEILING SYSTEMS

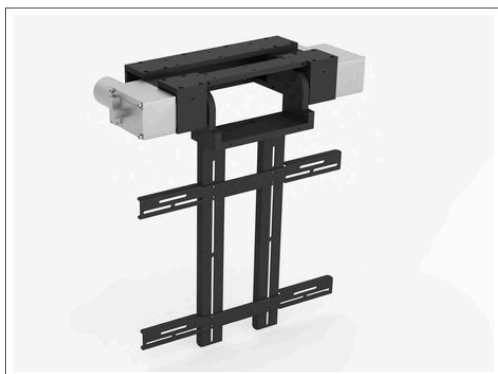

BS NAKED

CHARACTERISTICS

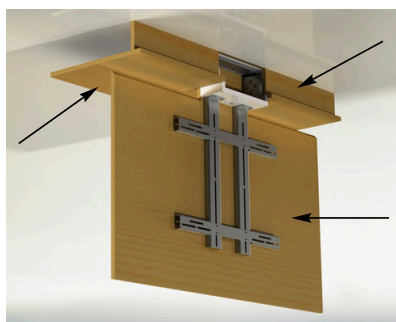
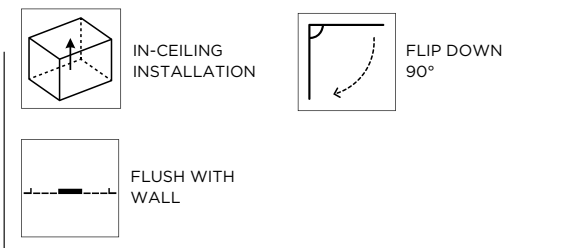



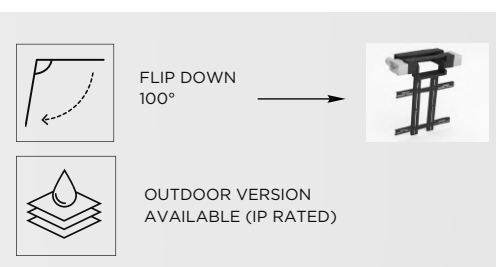

FINISH CEILING
PANEL MADE
BY OTHERS

OPTIONAL



BS NAKED SERIES

MODEL	DESCRIPTION	USEFUL TV	PRICE
 7032/42 BS	Flip Down Ceiling Mount	Max 42"	CONSULTAR
 7050/55 BS	Flip Down Ceiling Mount	Max 55"	CONSULTAR
 7065/70 BS	Flip Down Ceiling Mount	Max 70"	CONSULTAR
 7080 BS	Flip Down Ceiling Mount	Over 75"	ON REQUEST



FLIP DOWN 100° (EXTRA)



OUTDOOR VERSION AVAILABLE (EXTRA)



COVER BOX (EXTRA)



DEDICATED WOODEN BOX (EXTRA)

ROTATING NAKED CEILING SYSTEMS



BS NAKED

CHARACTERISTICS

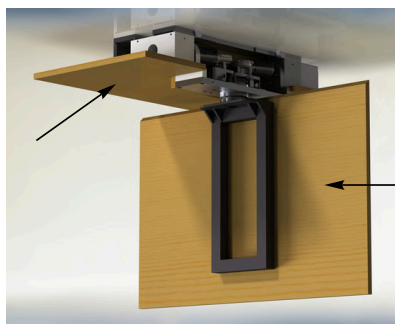
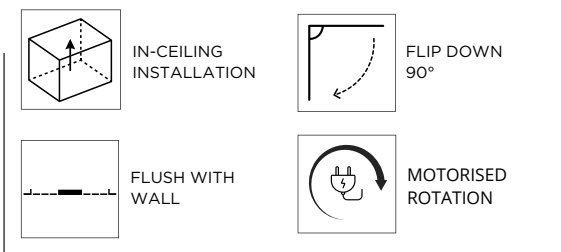

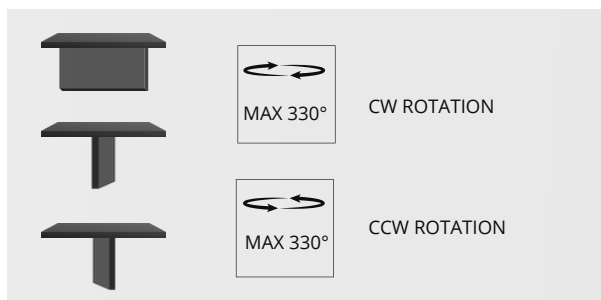

FINISH CEILING
PANEL MADE
BY OTHERS

ROTATION





BS TS NAKED SERIES

MODEL	DESCRIPTION	USEFUL TV	PRICE
 7050/60 BS TS	Flip Down Ceiling Mount with swivel	Max 60"	CONSULTAR
 7065/70 BS TS	Flip Down Ceiling Mount with swivel	Max 70"	CONSULTAR
 7080 BS TS	Flip Down Ceiling Mount with swivel	Over 75"	CONSULTAR

 OUTDOOR VERSION AVAILABLE (EXTRA)

 COVER BOX (EXTRA)

 DEDICATED WOODEN BOX (EXTRA)

 BOTH WAYS ROTATION - CW+CCW - (EXTRA)

BS YO-YO SYSTEMS



BS NAKED

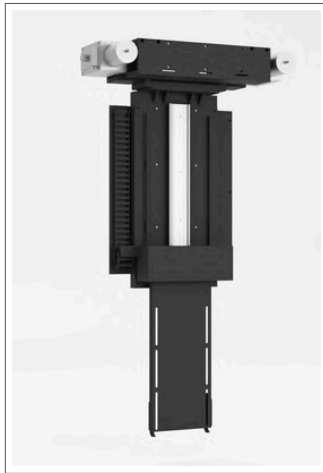

YO-YO SERIES

CHARACTERISTICS

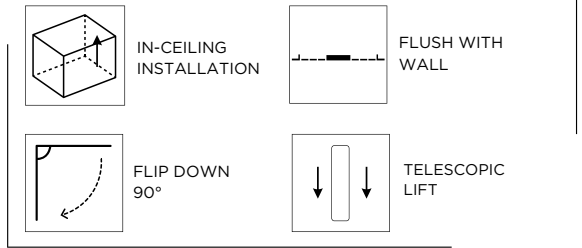

MOVEMENT SPECS

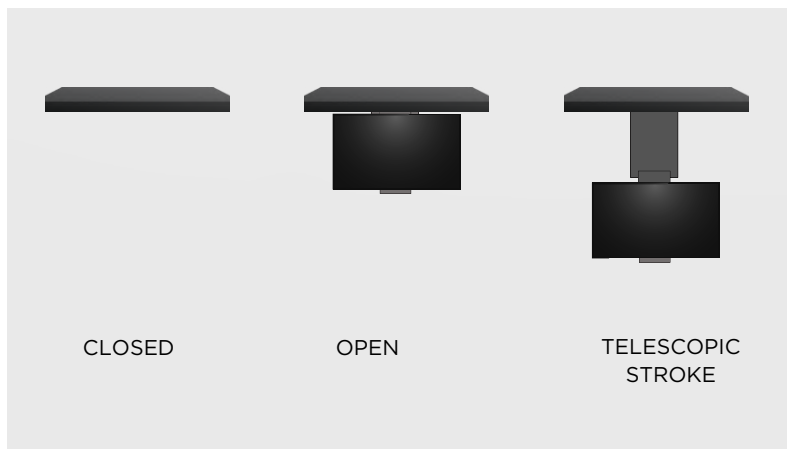

BS YO-YO SERIES

MODEL	DESCRIPTION	USEFUL TV	PRICE
7050/55 BS YO	Flip Down Ceiling Mount with telescopic lift	Max 55"	CONSULTAR
7060/65 BS YO	Flip Down Ceiling Mount with telescopic lift	Max 65"	CONSULTAR
7080 BS YO	Flip Down Ceiling Mount with telescopic lift	Over 75"	CONSULTAR



COVER BOX (EXTRA)



DEDICATED WOODEN BOX (EXTRA)

BS TS YO-YO CEILING SYSTEMS



YO-YO SERIES

CHARACTERISTICS

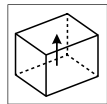

IN-CEILING
INSTALLATION

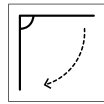

FLIP DOWN
90°

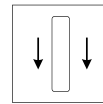

TELESCOPIC
LIFT

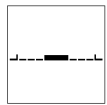

FLUSH WITH
WALL

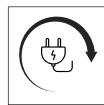

MOTORISED
ROTATION

MOVEMENT SPECS

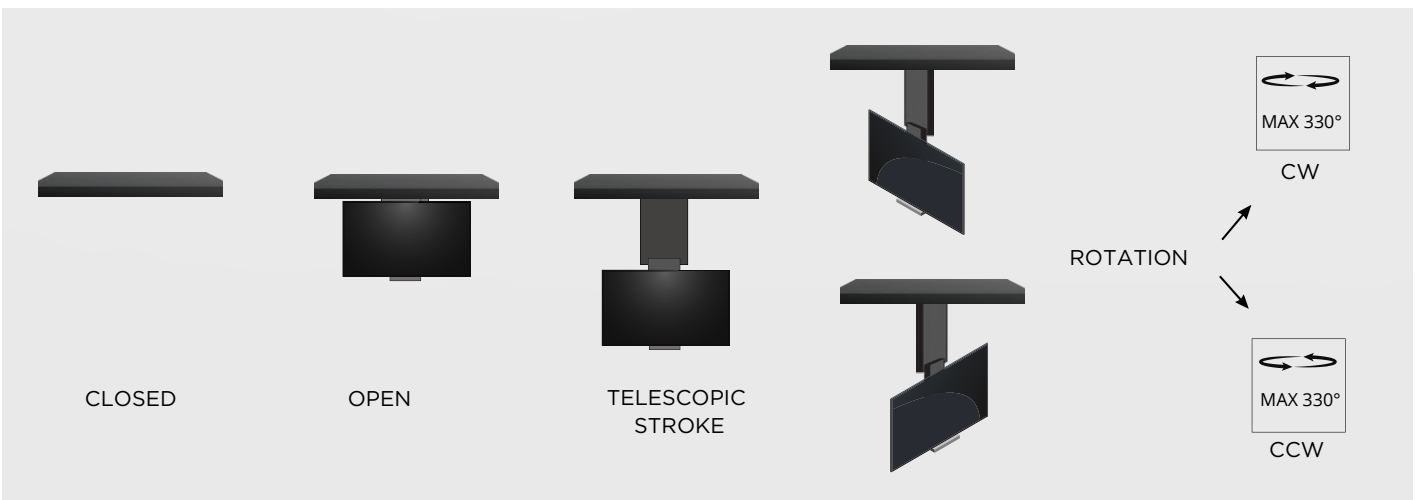

BS YO-YO SERIES

MODEL	DESCRIPTION	USEFUL TV	PRICE
7050/55 BS TS YO	Flip Down Ceiling Mount with telescopic lift and swivel	Max 55"	CONSULTAR
7060/65 BS TS YO	Flip Down Ceiling Mount with telescopic lift and swivel	Max 65"	CONSULTAR
7080 BS TS YO	Flip Down Ceiling Mount with telescopic lift and swivel	Over 75"	CONSULTAR



COVER BOX (EXTRA)



DEDICATED WOODEN BOX (EXTRA)



BOTH WAYS ROTATION - CW+CCW - (EXTRA)

UNDER-BED

UNDERBED FLIP UP SYSTEMS

Index

- Bub.....29
- Bub Yo.....29



UNDER BED TV LIFTS



UNDER BED SERIES

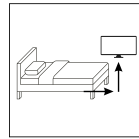

UNDER-BED
INSTALLATION

UNDER-BED FLIP-UP TV SYSTEM

MODEL	DESCRIPTION	USEFUL TV	PRICE
7010 BUB	Under bed Tv Lift	Max 55"	CONSULTAR



DEDICATED WOODEN BOX (EXTRA)

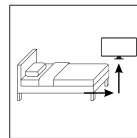
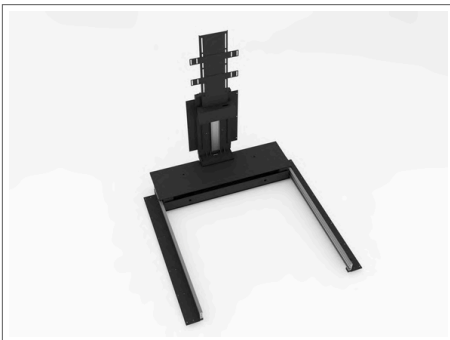

UNDER-BED INSTALLATION

UNDER BED SERIES

UNDER-BED FLIP-UP TV SYSTEM WITH TELESCOPIC LIFT

MODEL	DESCRIPTION	USEFUL TV	PRICE
7055 BUB YO	Under bed Tv mechanism with telescopic lift	Max 55"	CONSULTAR



DEDICATED WOODEN BOX (EXTRA)

REMOTE CONTROL



MODEL	DESCRIPTION	PRICE
7112-24	Remote control 4 chn	CONSULTAR

SAFETY & OPTIONAL

MODEL	DESCRIPTION	PRICE
BATTERIA TAMPONE	Backup Battery	TBD
PROXY SENSOR	Proximity sensor (antipinch function)	TBD
NO TOUCH CONTROL	Tv Lift with lateral rotation	TBD

POWER SUPPLY



MODEL	DESCRIPTION	PRICE
719424/10	Power Supply Transformer 110-240V 10A	CONSULTAR
719424/20	Power Supply Transformer 110-240V 20A	CONSULTAR

POWER SUPPLY

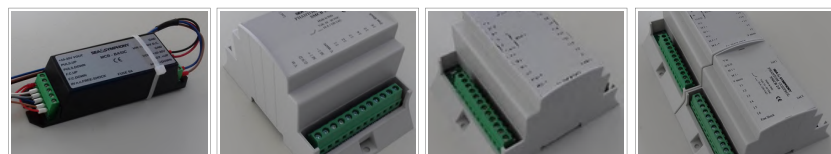

MODEL	DESCRIPTION	PRICE
MCB BASIC	12/24V control for Yo-Yo and Big Yo-Yo mechanisms	CONSULTAR
7112-24 SMCB	12/24V Logic control for single movement mechanisms	CONSULTAR
7112-24 DMCB	12/24V Logic control for double movement mechanisms	CONSULTAR
7112-24 MULTI DMCB	12/24V Logic control for multiple movement mechanisms	CONSULTAR

catálogo de referencias



sound-pixel.com
info@sound-pixel.com
+34 918 25 99 54



SoundPixelPlanet



SoundPixelPlanet España



Soundpixelplane



Sound Pixel Studios

**DISTRIBUTORS
ONLY**